



Evo Control System Installation Guide

2020.12 Version 1.0

Copyright © 2020 ePropulsion All Rights Reserved

Acknowledgement

Thanks for choosing ePropulsion products, your trust and support in our company are sincerely appreciated. We are dedicated to providing high-performance products and accessories.

Welcome to visit www.epropulsion.com and contact us if you have any concerns.

Using This Manual

Before use of the product, please read this user manual thoroughly to understand the correct and safe operations. By using this product, you hereby agree that you have fully read and understood all contents of this manual. ePropulsion accepts no liability for any damage or injury caused by operations that contradict this manual.

Due to ongoing optimization of our products, ePropulsion reserves the rights of constantly adjusting the contents described in the manual. ePropulsion also reserves the intellectual property rights and industrial property rights including copyrights, patents, logos and designs, etc.

This manual is subject to update without prior notice, please visit our website www.epropulsion.com for the latest version. If you find any discrepancy between your products and this manual, or should you have any doubts concerning the product or the manual, please visit www.epropulsion.com.

ePropulsion reserves the rights of final interpretation of this manual.

This manual is multilingual, in case of any discrepancy in the interpretation of different language versions, the English version shall prevail.

Symbols

The following symbols will help to acquire some key information.



Important instructions or warnings



Useful information or tips

Product Identification

Below picture indicates the serial numbers of Evo Remote Control and Evo Tiller. Please note the position of the serial numbers and record them for access to warranty service and other after-sale services.

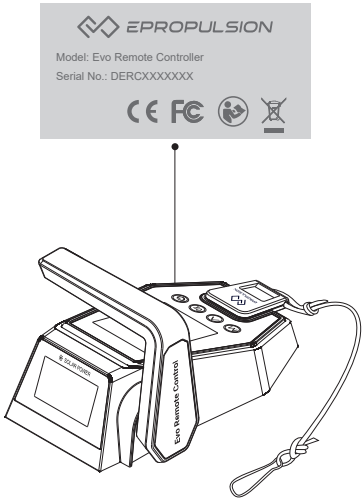

Figure 0-1

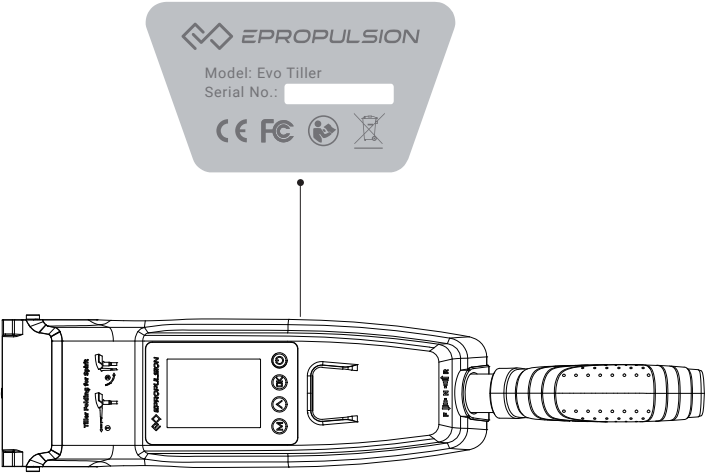

Figure 0-2

Table of content



Acknowledgement	1
Using This Manual	1
Symbols	1
Product Identification	2
1 Product Overview	4
1.1 In the Package	4
1.2 Parts and Diagrams.....	5
1.3 Specification.....	6
2 Installation	7
2.1 Mounting the Evo Remote Control	7
2.2 Mounting the Evo Tiller	7
2.2.1 Mounting on the SPIRIT 1.0 Evo	7
2.2.1 Mounting on the NAVY 3.0 Evo/NAVY 6.0 Evo	8
3 Wiring	9
3.1 Connecting the remote control and the outboard	9
3.2 Connecting the tiller and the outboard	9
4 Charging	10
4.1 Charging by solar power	10
4.2 Charging by wired connection	10
5 Use of Kill Switch	12
6 Warranty	13
6.1 Warranty Policies.....	13
6.2 Out of Warranty.....	14
6.3 Warranty Claim Procedures.....	14

1 Product Overview

The Evo Remote Control and Evo Tiller are used for starting and stopping the outboard motor, adjusting the speed of the motor, configuring the battery parameters, displaying the system information and messages, etc. The Evo Remote Control is powered by either solar power or the built-in lithium battery, but the Evo Tiller is powered by connecting to the outboard with a communication cable. Evo Remote Control wirelessly or wiredly communicates with the outboard control system built in the main outboard motor, and Evo Tiller can only wiredly communicate with the outboard. The Evo Tiller itself owns the steering capability, while using the Evo Remote Control, it requires an additional steering wheel to help steer.

1.1 In the Package

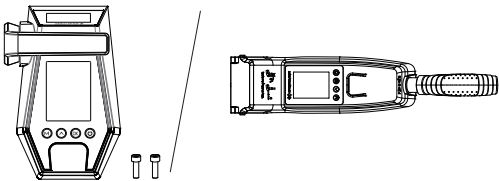
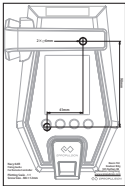
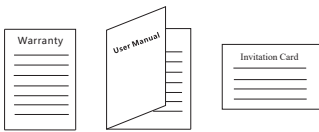
When you receive a set of Evo Remote Control or Evo Tiller, unpack its package and check if all the items below are included in the package. If there is any loss or transport damage, please contact your dealer immediately.

Items	Qty./Unit	Figure
Evo Remote Control / Evo Tiller	1 set	
Fixing Guide (Only provided with Remote Control)	1 piece	
User Manual, Warranty Card & Invitation Card	1 set	
Kill Switch	2 pieces	

1.2 Parts and Diagrams

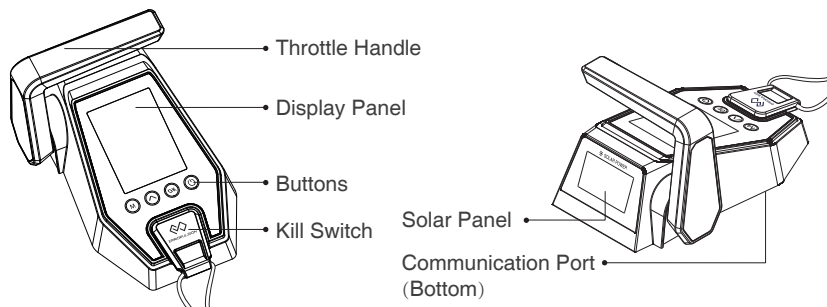

Figure 1-1

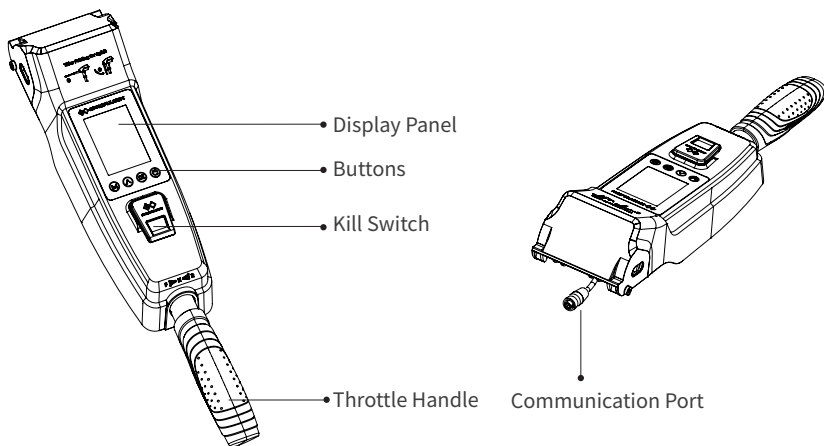

Figure 1-2

1.3 Specification

Evo Remote Control	
Communication	Wireless / Wired
Communication Distance	≤10 m
Weight	0.65 kg / 1.43 lbs.
Dimension (L x W x H)	193 mm x 130 mm x 112 mm / 7.6" x 5.1" x 4.4"

Evo Tiller	
Communication	Wired
Weight	1.1 kg / 2.43 lbs.
Dimension (L x W x H)	513 mm x 90 mm x 114 mm / 20.2" x 3.5" x 4.5"

2 Installation

2.1 Mounting the Evo Remote Control

Refer to the remote control fixing guide to punch holes on the ship board, and use the screws to lock the remote control box as shown in Figure 2-1.

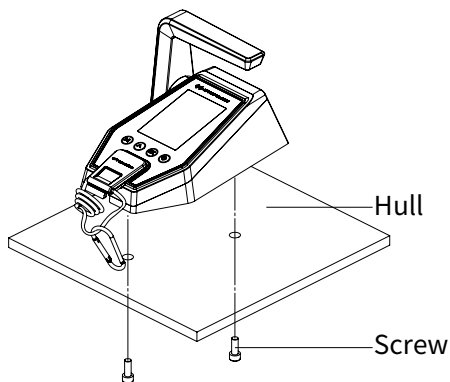

Figure 2-1

2.2 Mounting the Evo Tiller

2.2.1 Mounting on the SPIRIT 1.0 Evo

1. Install the tiller to the machine (Figure 2-2).
2. Insert the handle shaft into the hole to the end and lock it counter-clockwise (Figure 2-3).

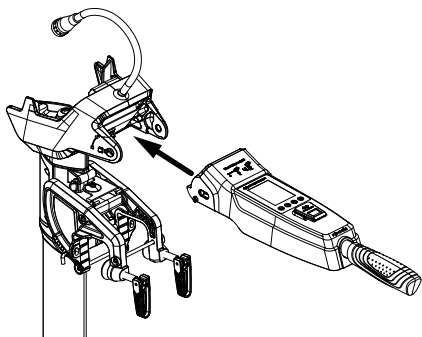

Figure 2-2

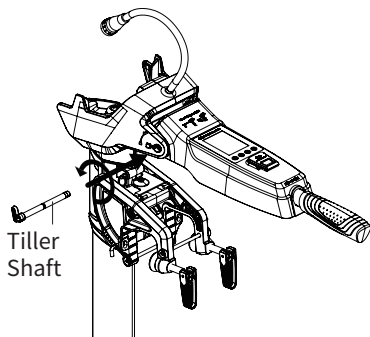

Figure 2-3

2.2.1 Mounting on the NAVY 3.0 Evo/NAVY 6.0 Evo

1. Install the tiller to the machine (Figure 2-4).
2. Insert the handle shaft into the hole to the end and lock it clockwise (Figure 2-5).

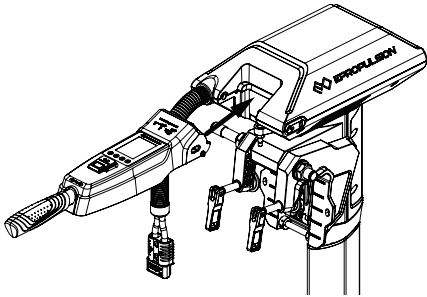

Figure 2-4

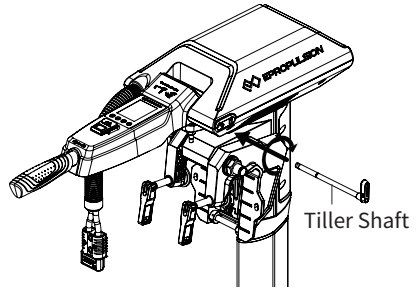

Figure 2-5

3 Wiring

3.1 Connecting the remote control and the outboard

If the remote control needs to be connected with the machine by wire, a communication cable is needed to connect the machine and the remote control Communication port (Figure 3-1).

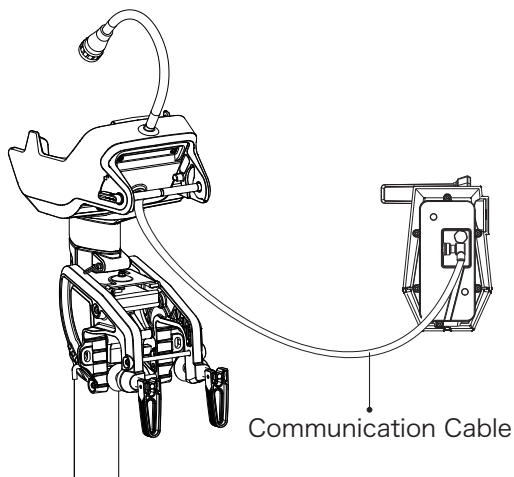

Figure 3-1

3.2 Connecting the tiller and the outboard

After mounting the tiller, you need to connect the communication port of the tiller to the communication port of the machine (Figure 3-2).

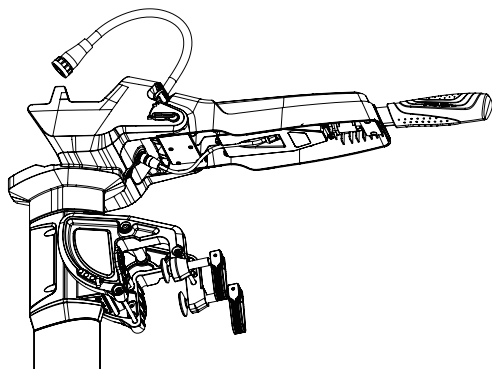

Figure 3-2

4 Charging

The Evo Remote Control has a built-in lithium battery for power supply. The battery will be charged automatically under normal use: get charged by solar power or wired connection. The Evo Tiller does not have a built-in battery and needs to be connected to the machine.

4.1 Charging by solar power

When the solar panel receives enough sunshine, it will generate electricity to charge the built-in lithium battery. While charging the battery by solar power, it's suggested to face the solar panel of the Remote Control toward sunlight to get better charging effect.

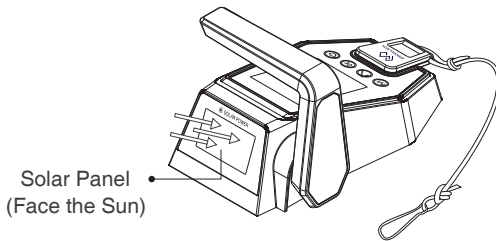



Figure 4-1

 It's recommended to charge the Remote Control by solar power.

4.2 Charging by wired connection

If the Evo Remote Control can't get enough solar power for a long time, the battery level will run out. In this case, a warning message with an error code E60 (Figure 4-2) will display on the LCD panel to remind you to charge the Remote Control.

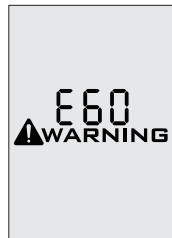

Figure 4-2

Please follow the below steps to charge the Remote Control by wired connection.

First, connect the Remote Control to the outboard motor by a communication cable first (Figure 4-3);

Then, connect the outboard motor to the battery.

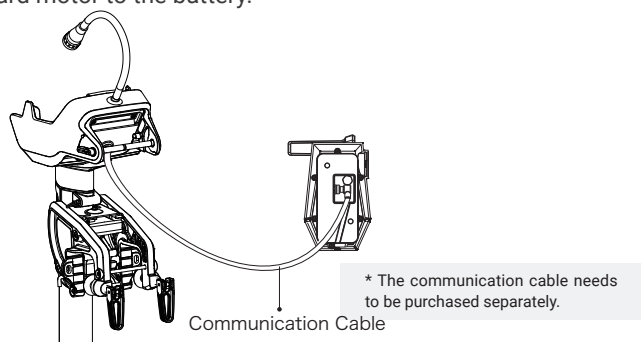





Figure 4-3

 During long-term storage, ensure to charge the Remote Control battery every 6 months to avoid over-discharge.

 After long-term storage, charge the Remote Control before use.

 The communication cable is not included in this package. Please purchase one from your dealer if you choose this charging method.

 It's recommended to switch off the Remote Control while connecting the communication cable. When the Remote Control is switched on while charging, as the outboard main part and Remote Control are in communication, the working outboard motor will stop once the communication cable disconnects.

5 Use of Kill Switch

- Locate the kill switch to the right place on the Evo Remote Control / Evo Tiller and tie its lanyard to your wrist or life jacket.
- Stop the outboard in emergency by detaching the kill switch.
- To run the motor again, first attach the kill switch then start the motor.

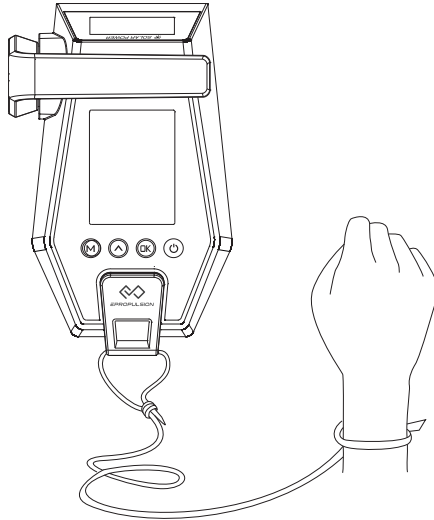



Figure 5-1

-  The kill switch generates magnetic field. Keep it 50cm / 20inches away from medical implants like pacemakers and magnetic cards (e.g. credit card) as well as other magnetic media.
-  The magnetic field of the kill switch may interfere with some electronic instruments. Keep it away from these electronic instruments.





6 Warranty

The ePropulsion limited warranty is provided for the first end purchaser of an ePropulsion product. Consumers are entitled to a free repair or replacement of defective parts or parts which do not conform with the sales contract. This warranty operates in addition to your statutory rights under your local consumer law.

6.1 Warranty Policies

ePropulsion warrants its products to be free of defects in material and workmanship for a limited period since the date of purchase. Once a fault is discovered, the user has the right to make a warranty claim under the ePropulsion warranty policies.

Product	Warranty Expiry Date
Evo Remote Control / Evo Tiller	Two years after the date of purchase.
Components have been repaired or replaced	<p>Three months since the date of maintenance.</p> <p>Note:</p> <ol style="list-style-type: none"> 1. If the three-month period overlaps with the original warranty period, the warranty against these replaced or repaired parts still expires two years after the date of purchase. 2. If the three-month period exceeds the original warranty period, the repaired or replaced parts continue applying to warranty during the extended period.

-  In order to validate the warranty, users are required to fill in the Warranty Card in the package in advance.
-  Keep the product label in intact state and record the serial number on the label. Never tear the label off the product. An ePropulsion product without the original product label will not be applicable to warranty services provided by ePropulsion.
-  The warranty is valid only when the information is correct and complete.
-  Free warranty is only validated upon the presentation of legal serial number, Warranty Card, and evidence of purchase from an authorized ePropulsion dealer.
-  Valid date of purchase should be established by the first-hand purchaser with original sales slip.



Free warranty is not transferable and will not be reissued.



Within the limits of the applicable laws, the warranty policies of ePropulsion may update without prior notice. The latest version is available at our website www.epropulsion.com.

6.2 Out of Warranty

Make sure the product is properly packed during delivery, the original ePropulsion package is recommended. If the product got further damaged due to improper packing during delivery, the furtherly damaged part will be deemed as out of warranty coverage.

In addition, faults or damages caused by the following reasons are also excluded from warranty scope within the covered period:

- Any improper operation contradicts the user manual.
- Accident, misuse, wishful abuse, physical damage overcharging, liquid damage or unauthorized repair.
- Dropping, improper care or storage.



You should be noted that minor faults like normal wear and tear that pose no influence on the intended function of the product are also not covered by the warranty.



Consumables are out of warranty scope.

6.3 Warranty Claim Procedures

If you find your product defective, you can make a claim to your dealer following below procedures:

1. Fill in the Warranty Card correctly and completely in advance. Then make your warranty claim by sending it to your authorized ePropulsion service partner together with valid proof of purchase. Usually these documents are required when making a warranty claim: the Warranty Card, ex-factory serial number, and evidence of purchase.
2. Send the defective product to your authorized ePropulsion service point after getting the confirmation. Note that the label should be kept intact. You can also deliver the product to your authorized ePropulsion dealer after getting confirmation.

1. The defective components or parts will be either repaired or replaced according to the diagnosis made by the ePropulsion authorized service partner.
2. If your warranty claim is accepted, the equipment will be repaired or replaced free of cost. Note that any delivery cost incurred in the process is at your charge.
3. After careful examination and confirmation by ePropulsion authorized dealer, the defective or faulty components will be repaired or replaced with brand new ones against the actual condition.
4. In case your warranty claim is rejected, an estimated repair charge with round trip delivery cost will be sent for confirmation. ePropulsion authorized service point will conduct maintenance accordingly only after your confirmation.



If warranty expires, you can still enjoy maintenance services from authorized ePropulsion service partners with minimum maintenance charge.

Thanks for reading this user manual.

If you have any concerns or find any problems while reading, please don't hesitate to contact us. We are delighted to offer service for you.

Guangdong ePropulsion Technology Limited

Website: www.epropulsion.com

Email: service@epropulsion.com