

INTELLIGENT SOLAR CHARGE CONTROLLER USER'S MANUAL

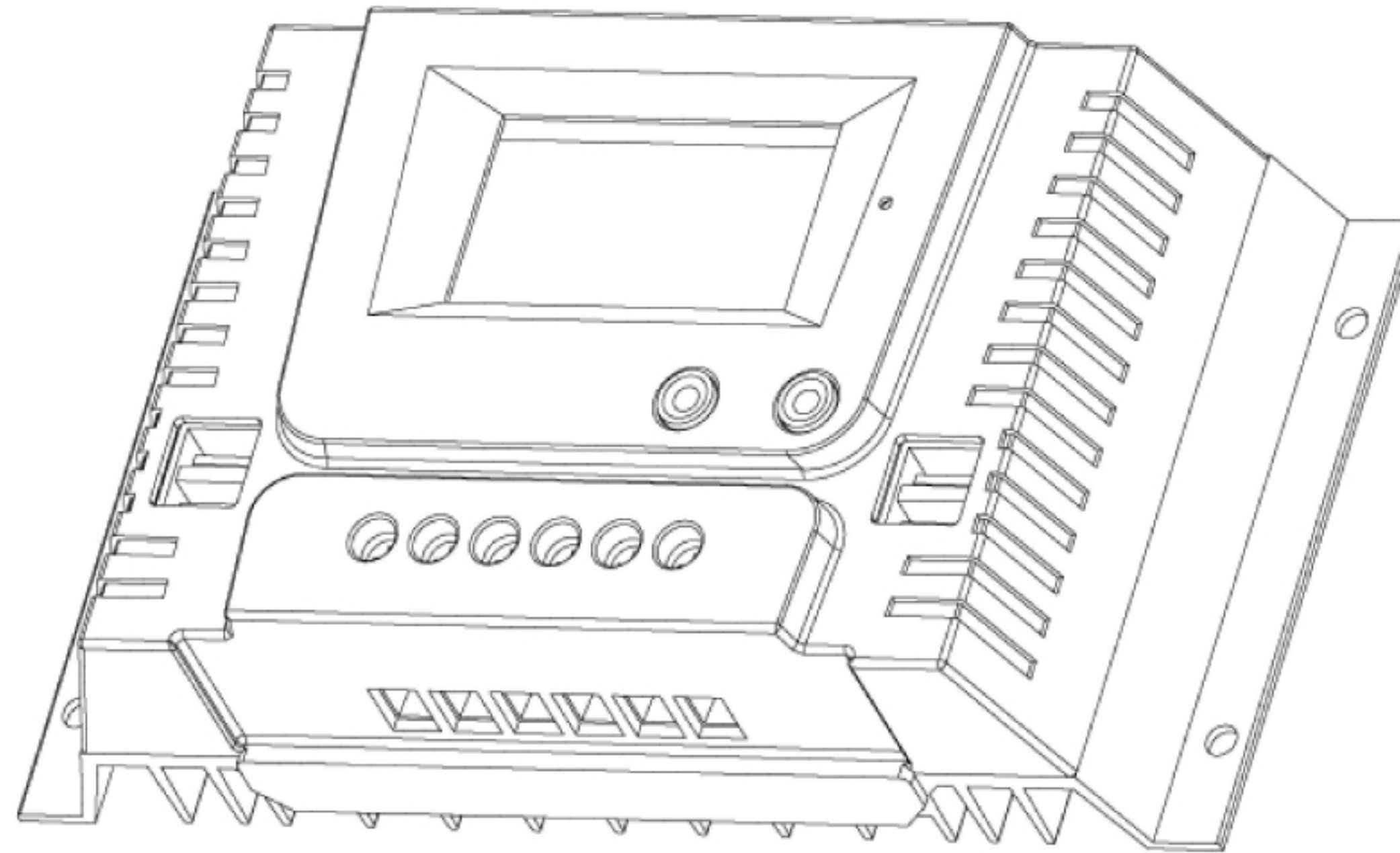

Thank you for choosing this series Solar Charge Controller. Please read this Manual carefully before using the product.

1. Product Features:

This series controller is a PWM charge controller with built in LCD that adopts the most advanced digital technique. The multiple load control modes enable it can be widely used on solar off grid system, traffic signal, solar street light, etc.

- System voltage of battery 12V/24V or 12V/24V/36V/48V automatic recognition;
- Intelligent 4 stages PWM charging: Bulk, Absorption, Equalize, Float;
- LCD display with Back-lighting shows device's operating data and working condition;
- Humanized simple button operation; Adjustable charge-discharge control parameters;
- Support more kinds of battery: Lead-acid battery (Sealed, Gel, Flooded) and Lithium battery (LiCoMnNiO₂, LiFePO₄);
- Multiple load control modes: 24Hours Working Control, Light Control, Light and Dual Time Control;
- Automatic temperature compensation and accumulated function of charge and discharge KWH;
- Double USB output 5V/2A;
- Perfect electronic protections.

Contents

1. Product Features	1-1
2. System Connection	2-2
3. Operation	3-9
4. Protections	10-11
5. Troubleshooting	11-11
6. Technical Specification	12-12

2. System Connection:

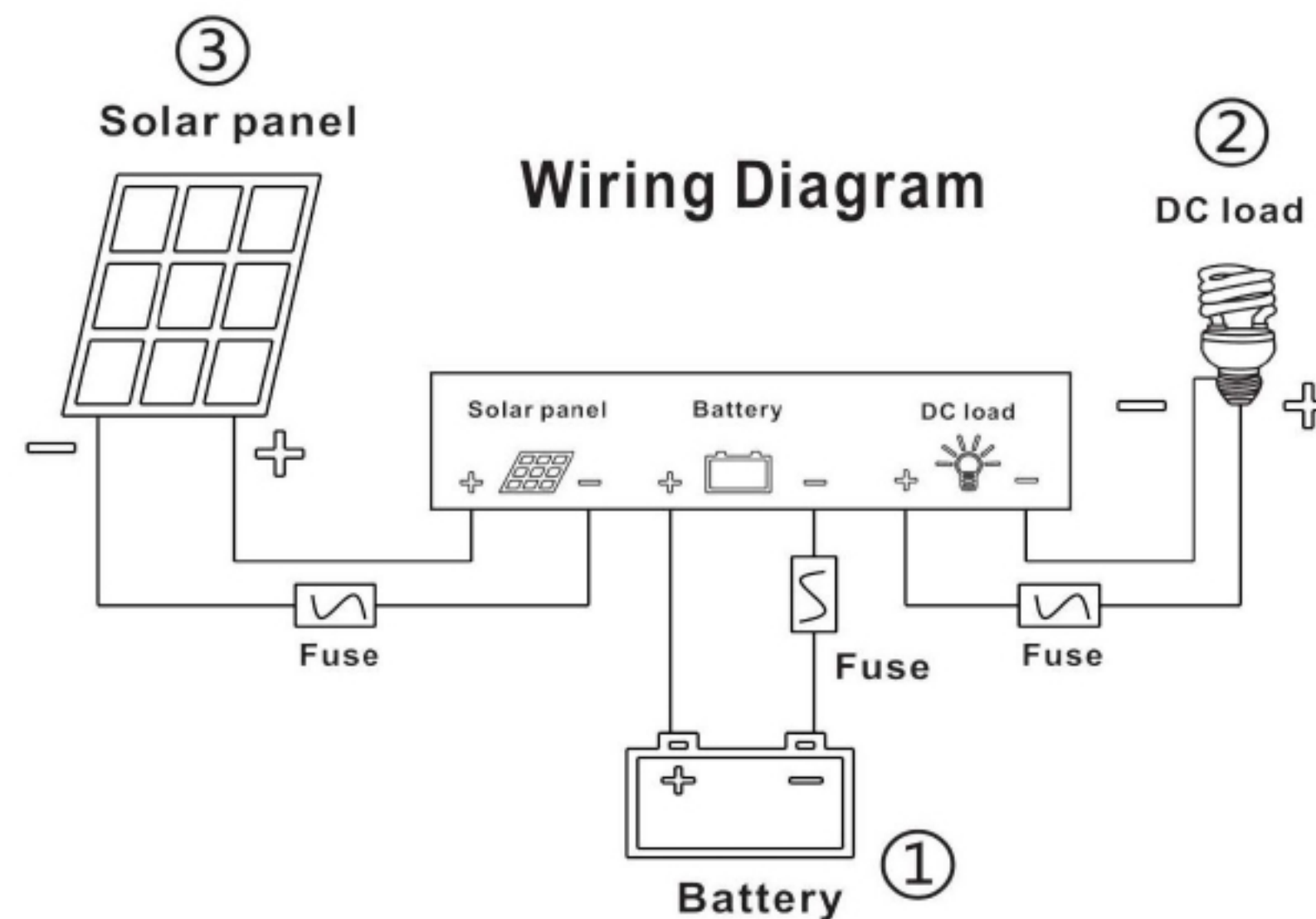

2-1. Order of Connection:















- ① Connected with Battery first; ② Connected with Load; ③ Connected with Solar Panel.

NOTE:

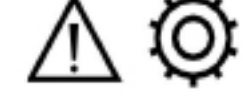
- ① This series is a positive ground controller. Any positive connection of Solar Panel, Load or Battery can be earth grounded.
- ② The fuse should be installed as close to battery as possible, the suggested distance is about 150mm;
- ③ If inverter or other load with big start current is necessary in system, please connect it with Battery, not solar controller;
- ④ When disconnecting the system, the order will be reversed.

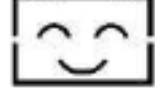
3. Operation:

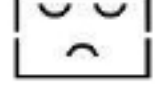
3-1. LCD Symbol:

Icon	Meaning	Icon	Meaning	Icon	Meaning
	Day		Data Relates to Charging	FLT	Float Charging
	Night		Data Relates to Discharging	ABS	Absorption Charging
	Charging		Data Relates to Temperature	EQU	Equalizing Charging
	No Charging		Data Adjustable	SCI	Max Charging Current
	Load On		Data not Adjustable	RCV	Recovery Charging Voltage
	Load Off		Sealed Battery	SCV	Constant Charging Voltage
	System Works Normally		GEL Battery	LVD	Low Voltage Disconnection Voltage
	System Works Abnormally		Flooded Battery	LVR	Low Voltage Re-connection Voltage

3-2. Button Function:

Modes	Operation
Browse Interface	Short press button “+” or “-”.
Load On/Off	When load in 24H working mode, short press button “-” in Main interface.
Parameter Setting	In the settable interface, long press button “+” into setting, and then short press “+” or “-” to set parameter, long press button “+” to save and exit. (Long press button “-” to cancel the parameter and back to last setting)
Factory Reset	Long Press button “+” 5s in the interface of Ambient Temperature.

3-3. Browse Interface:

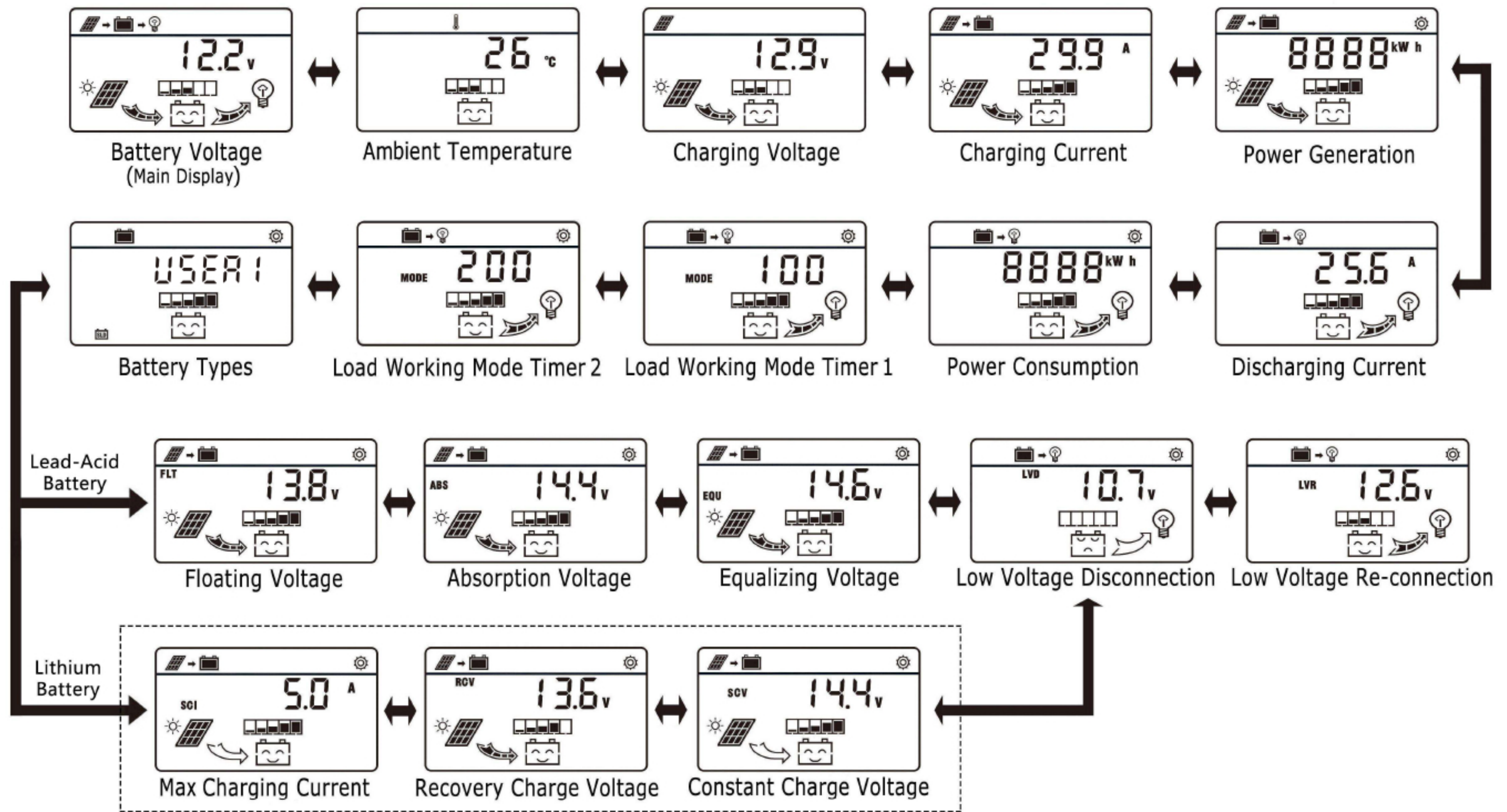

-5-

NOTE:

- ① After connected with Battery, LCD will go into an interface that automatically recognizes the battery voltage level, 3 seconds later, it will enter to the main interface of LCD;
- ② Equalizing charge will be after every 90 times Floating charge, or one charge in three months;
- ③ **Default maximum charging current of Lithium battery is 5A, but it can be adjusted by users within the rated current range**
- ④ Under the interface of Accumulated KWH, long press button “+” to clear the value;
- ⑤ When no operation 30s, the interface will be back to main interface, and back-light will be turned off.

3-4. Battery Types:

Under the interface of battery types, long press button “+” into the type setting, then short press button “+” or “-” to choose battery type, and then long press “+” again to save and exit.

Icon	Battery Type
SLD	Sealed Battery (Default)
GEL	Gel Battery
FLD	Flooded Battery
USE1	Lead-Acid Battery (User-defined)
3.2-4	LiFePO4: 3.2V-4S /8S /12S /16S
3.2-5	LiFePO4: 3.2V-5S /10S /15S /20S
3.7-3	LiCoMnNiO2: 3.7V-3S /6S /9S /12S
3.7-4	LiCoMnNiO2: 3.7V-4S /8S /12S /1
6SUSE2	Lithium Battery (User-defined)

-6-

3-5. Battery voltage automatic identification range:

Battery Types	Lead-Acid Battery	Lithium Battery			
		LiFePO4 3.2V-4	LiFePO4 3.2V-5	LiCoMnNiO2 3.7V-3	LiCoMnNiO2 3.7V-4
12V System	≤17.6V	≤18V	≤22.5V	≤15.9V	≤21.2V
24V System	≤29.9V	≤30.4V	≤38V	≤26.9V	≤35.8V
36V System	≤42.1V	≤42.8V	≤53.5V	≤37.8V	≤50.4V
48V System	>42.1V	>42.8V	>53.5V	>37.8V	>50.4V

3-6. Control parameters of Lead-acid battery:

Lead-Acid Battery Types	SLD				GEL				FLD			
	12V	24V	36V	48V	12V	24V	36V	48V	12V	24V	36V	48V
Battery Voltage Level	12V	24V	36V	48V	12V	24V	36V	48V	12V	24V	36V	48V
Float Charging Voltage	13.8V	27.6V	41.4V	55.2V	13.8V	27.6V	41.4V	55.2V	13.8V	27.6V	41.4V	55.2V
Absorption Charging Voltage	14.4V	28.8V	43.2V	57.6V	14.2V	28.4V	42.6V	56.8V	14.6V	29.2V	43.8V	58.4V
Equalizing Charging Voltage	14.6V	29.2V	43.8V	58.4V	NO				14.8V	29.6V	44.4V	59.2V
Charging time of Absorption/Equalizing	2 Hours											

Lead-Acid Battery Types	SLD / GEL / FLD			
	12V	24V	36V	48V
Battery Voltage Level	12V	24V	36V	48V
Low Voltage Disconnection	10.7V	21.4V	32.1V	42.8V
Low Voltage Re-connection	12.6V	25.2V	37.8V	50.4V
Load Over-Voltage Disconnection	16V	32V	48V	64V
Load Over-Voltage Re-connection	15.5V	31V	46.5V	62V

3-7. Control parameters of Lithium battery:

Lithium Battery Type	LiFePO4							
	3.2-4				3.2-5			
Icon	4S	8S	12S	16S	5S	10S	15S	20S
Recovery Charging Voltage	13.6V	27.2V	40.8V	54.4V	17V	34V	51V	68V
Constant Charging Voltage	14.4V	28.8V	43.2V	57.6V	18V	36V	54V	72V
Stop Charging Current	0.1A				0.1A			
Low Voltage Disconnection	11.2V	22.4V	33.6V	44.8V	14V	28V	42V	56V
Low Voltage Re-connection	12.8V	25.6V	38.4V	51.2V	16V	32V	48V	64V
Load Over-Voltage Disconnection	18.5V	37V	55.5V	74V	18.5V	37V	55.5V	74V
Load Over-Voltage Re-connection	18V	36V	54V	72V	18V	36V	54V	72V

3-8. Load Working Modes:

Under the load mode setting interface, long press button “+”, when Timer 1 or Timer 2 begin flashing, short press button “+” or “-” to set parameter, then long press button “+” to save and exit.

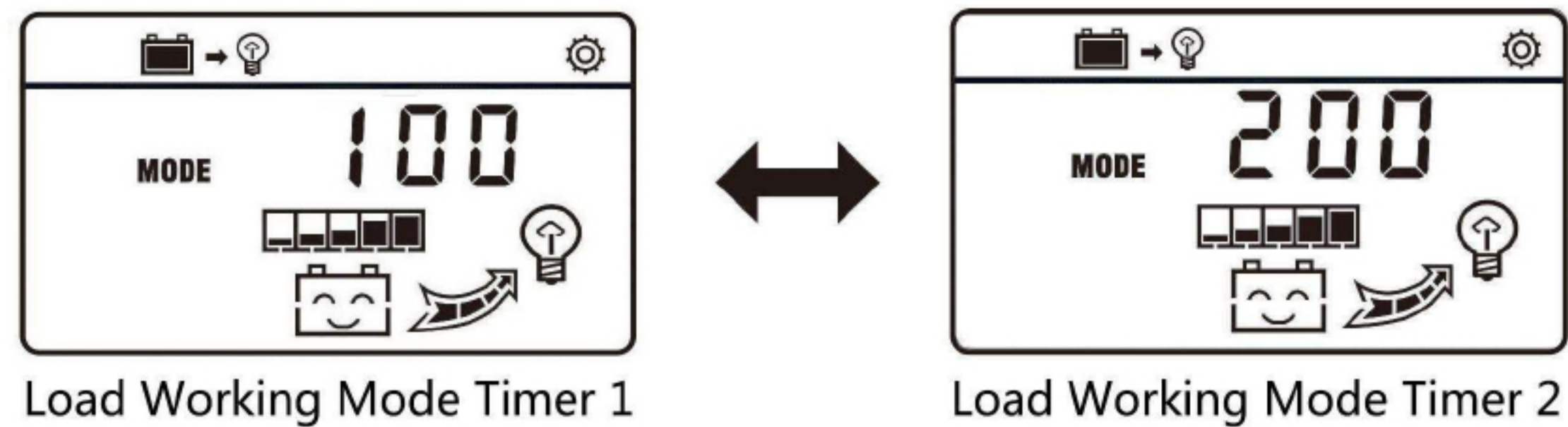

Icon	Load Working Mode Timer 1	Icon	Load Working Mode Timer 2
100	Reverse light control mode (The load stops working at dark and working at dawn)	200	Light control & Dual period mode is not activated, unable to enter the setting
101h~115h	Light control & dual time mode: the load is automatically turned on when it is dark, and it is automatically turned off when it is dawn. The 1h-15h on this page is used to setting the working time of the load after dark	201h~215h	After activating the light control & Dual period mode, you can enter this page to set 1H ~ 15h to control the working hours of the load before dawn
116	Light control mode	117	Load 24 hours

4. Protections:

- Solar Panel Reverse-Polarity:
If the solar panel is connected with controller in reversed polarity, controller will not be damaged and will work as normal when correctly connected.
- Battery Reverse-Polarity:
If the battery is connected with controller in reversed polarity (solar controller is not connected with solar panel), controller will not be damaged and will work as normal when correctly connected.
- Battery Reverse-Discharge:
Controller is able to protect battery from reversed discharging to solar panel at night.
- Over-Heating Protection:
Once the internal temperature is detected to be higher than a certain value by the controller, it will stop charging the battery and then recharging the battery automatically after the temperature drop to a certain value.
- Battery Over-Current:
Controller will stop charging when excess current is detected from the solar panel, and recharging automatically after 2 min.
- Load Over-Load:
The load will be turned off when the output current of load exceeds its rated current for a while, and turned on automatically after 2 min.
- Load Short-Circuit:
Controller will be in protection state when the load is short circuit, and recharging automatically after 2 min.
- Battery Low-Voltage:
Controller will turn off the load when the battery voltage is lower than the value preset for low-voltage disconnection, and turn on the load when the battery voltage reaches the value preset for low-voltage re-connection. The value for low-voltage disconnection and low-voltage re-connection can be set by users in a certain range.

- **Battery Over-Voltage:**

Controller will turn off the load when the battery voltage is higher than the value preset for over-voltage protection, and turn on the load when the battery voltage is 1V lower than the value preset for over-voltage protection.

- **Lightning Protection:**

The lightning protection function of controller is limited and it is recommended to install devices for lightning protection on the input side to increase system reliability.

5. Troubleshooting:

Error Code	Cause	Solution
E01	Battery Low-Voltage	Recharging the battery or change a new one.
E02	Load Over-Load	Check the loads connection or reduce the electric equipment.
E03	Load Short-Circuit	
E04	Load Over-Voltage	
E05	Solar Panel Over-Current	Check the power of solar panel or reduce the solar panel.

6. Technical Specification:

Max Current	10A20A
Battery Voltage	12V/24V/36V/48V Auto
Max PV Open Circuit Voltage	100V
Self-consumption	≤30mA
Loop Voltage Drop	≤0.3V
USB Output	5V/2A *2
Temperature Compensation	-4mV/°C/2V (25°C)
Operating Temperature	-20°C~+50°C
Protection Category	IP32
Humidity	95%, no-condensing
Terminals	8AWG/10mm ²
Mounting Hole Size	158*68mm-Φ6mm
Dimension	168*88*36mm
Weight	0.22KG