

Jabsco Pumps 37245-3094

www.jabscopumps.com - Click here for Pricing/Ordering Information **Model 37245-Series**

QUIET-FLUSH ELECTRIC TOILET FEATURES

- Very quiet flush cycle - like a household toilet
- Single button flush actuator - with dual function water level control switch
- Supplied with PAR-MAX 2.9 self priming pump to provide sea or lake or river water to rinse the bowl
- White vitreous china bowl available in compact or comfortable household size
- Baked enamel seat & cover - soft close seat option available on regular bowl models
- High capacity waste macerator and bowl discharge pump

SPECIFICATIONS

Ports: PAR-MAX 2.9 and Toilet
Pump Inlet 3/4" (19mm) Hose Barb
Toilet Outlet 1" (25mm) Hose Barb

Motor & Switch: Pump and Toilet meet U.S.C.G. Regulation 183.410 and ISO 8846 Marine for Ignition Protection. 

Water Consumption: 1-2 Quarts (Litres)/Flush

VARIATIONS

Model Number	Description
37245-3092	Compact Bowl 12V
37245-3094	Compact Bowl 24V
37245-4092	Regular Bowl 12V
37245-4192	Regular Bowl 12V, Soft Close Seat/Lid
37245-4094	Regular Bowl 24V
37245-4194	Regular Bowl 24V, Soft Close Seat/Lid



Model 37245-Series

OPERATION

The Quiet-Flush toilet provides both quiet operation and user control of water levels in the toilet bowl. A single rocker switch provides a simple flush mode by activating both the rinse water supply and the macerator discharge pump simultaneously. An additional dual action rocker switch offers independent control of the rinse water supply and discharge pump separately so the bowl water level can be easily raised or lowered by the user. This provides a method of minimizing water use, when desired, as well as a means of raising the water level in the bowl when appropriate for user comfort. It also allows for complete evacuation of the bowl water while underway in rough sea conditions.

INSTALLATION

The 37245-Series Quiet Flush Toilet is complete with a dedicated PAR-MAX 20 pump. The pump provides either creek or lake water to rinse the toilet bowl when flushing the toilet. This pump is intended to be located remotely from the toilet but will function best if the distance from the toilet is kept to a minimum. Because it is self-priming, it may be located above the vessel's waterline. It must be installed with the Pumpgard strainer (provided with the toilet) located somewhere in the inlet plumbing to the pump. The toilet also includes a multi-function flush control which should be installed in a bulkhead location that is convenient to the toilet and allows access for wiring to run from the power source and to both the toilet discharge pump and the PAR-MAX rinse water pump.

Install the toilet seat and lid assembly on the china bowl with the fasteners provided and position the toilet in its desired location. When locating the toilet, ensure there is adequate clearance above and to the rear of the bowl so the seat and lid assembly can rotate slightly past vertical so it will remain up when lifted. It is all right to rotate the waste pump assembly under the china bowl to provide clearance from possible obstructions, if desired. This can be accomplished by removing the four white plastic hex head caps from the nuts at the base of the china bowl and removing the four machine screws and nuts that secure the china bowl to the base. The base can then be reattached to the bowl at any position in 90° increments. Once the exact position for the toilet has been determined, mark the location of the four base attachment holes on the toilet mounting surface. Determine the best toilet attachment method using 5/16" (8 mm) fasteners (either machine screws for through bolting or lag screws for topside attachment) and drill the appropriate size holes for the fasteners being used. If securing the toilet with lag screws into a plywood underlayment below fiberglass, be sure to drill a hole through just the fiberglass layer large enough to allow clearance for the screw threads and shank to avoid cracking the fiberglass.

The PAR-MAX pump should be mounted to a solid mounting surface. It should be secured with four fasteners through the rubber grommets that snap into the pump's base. Do not over-tighten the mounting screws and crush the grommets such that they will not absorb vibration. The pump may be mounted in any position; however, if mounting it to a vertical surface it should be oriented so water dripping from a loose port connection will not drip down on the motor. Plumbing runs should be kept as short and straight as possible. All plumbing should be completed with quality 3/4" (19 mm) hose that will not collapse or kink. Route the inlet hose from a 3/4" (19 mm) through hull and seacock fitting located well below the waterline (and well forward of any discharge through hulls, if installed) to the pump inlet port. Ensure the inlet hose passes through an accessible location (preferably above the vessel's waterline) that will allow for the installation of the Toilet Pumpgard strainer where it can be periodically inspected and cleaned of debris.

The Pumpgard strainer should be secured with two fasteners to a solid mounting surface with the flow arrow pointing towards the pump. The inlet hose should be cut and each end attached to the strainer's ports. The hose from the strainer's discharge port must connect with the PAR-MAX pump's inlet port. Provided with the toilet is a six foot length of smooth white aesthetically pleasing hose to connect to the back of the toilet bowl and be routed out of the head area. Ideally, the PAR-MAX pump should be located so this length of hose can be connected directly to the pump's discharge port avoiding an additional splice to the hose leading from the pump to the back of the toilet bowl. If this is not practical, acquire a 3/4" (19 mm) barb to barb hose mender and splice the white hose to the supply hose from the discharge port of the pump.

	WARNING Flood hazard. If toilet is installed below the waterline, it must be installed with a properly positioned vented loop in the discharge hose. Failure to do so can result in flooding which can cause loss of property and life.
---	--

If the toilet is installed below the vessel's waterline, in order to prevent a siphon action from filling the toilet, a properly positioned vented loop fitting must be installed between the PAR-MAX pump and the back of the toilet bowl. The vented loop fitting must be secured in a location that remains at least 6-8 inches (15-20 cm) above the waterline at all angles of heel and trim (see diagram).

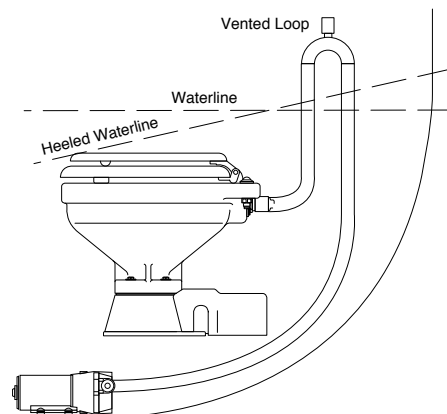

The toilet discharge port is sized for 1" (25 mm) hose. The discharge hose should be a quality grade reinforced hose suitable for waste applications. Route the discharge hose to the holding tank in the most direct way with as few bends as possible. To retain some water in the bowl, it is best to loop the discharge hose up about 8-10 inches (15-20 cm) as close to the toilet as practical then on to the holding tank. It is best to avoid any dips or low spots in the discharge plumbing that can act as water traps and collect waste. If this occurs, waste can solidify and cause a discharge blockage.

If the toilet is plumbed to an overboard discharge, and is below the vessel's waterline, the discharge plumbing must include a properly positioned vented loop. The vented loop fitting must be secured in a location that

ELECTRICAL SPECIFICATIONS

VOLTAGE	AMP DRAW	FUSE SIZE	Jobco Pumps 37245-3094				
			0'-10' (0 M-3 M)	10'-15' (3 M-4.6 M)	15'-25' (4.6 M-7.6 M)	25'-40' (7.6 M-12.2 M)	40'-60' (12.2 M-18.3 M)
12 Vdc	10	25	#16 (1.3 mm ²)	#14 (2.5 mm ²)	#12 (4 mm ²)	#10 (6 mm ²)	#8 (10 mm ²)
24 Vdc	5	15	#16 (1.5 mm ²)	#16 (1.5 mm ²)	#16 (1.5 mm ²)	#14 (2.5 mm ²)	#12 (4 mm ²)

* Length of run is total distance from power source to product and back to ground.

remains at least 6-8 inches (15-20 cm) above the waterline at all angles of heel and trim. The maximum discharge head without a notable decrease in pump performance is four feet (1.3 M).

ELECTRICAL

The electrical wiring should be independent of all other accessories. It should be made with marine grade copper stranded wire of the gauge specified in the electrical specifications chart. Make all wire connections with mechanical locking type connectors (crimp type butt connectors and terminals). Ensure the circuit is protected by a proper sized fuse or circuit breaker determined from the electrical specifications chart. Secure all wires to a solid surface approximately every eighteen inches (1/2 M) along their entire length of run.

Wire the switch panel to the PAR-MAX rinse pump and toilet waste pump as per the following wiring diagram. The brown lead from the control panel connects with the waste pump orange (positive) motor lead. The yellow lead from the control panel connects with the PAR-MAX rinse water pump orange (positive) motor lead. The black motor lead from each pump must be connected to battery negative. Select a location for the switch panel that is convenient to the toilet user and will also allow access to run the wires from the switch panel to both the toilet's waste pump motor and the PAR-MAX pump as well as from the electrical power source to the switch panel. To install the switch panel, drill two 1-3/4" (45 mm) diameter holes (slightly over-lapping) through the selected switch mounting surface per the attached template. Ensure the template is oriented correctly because it is not symmetrical. Also, drill four appropriate sized holes for the fasteners selected to secure the switch panel to its mounting surface.

WIRING DIAGRAM

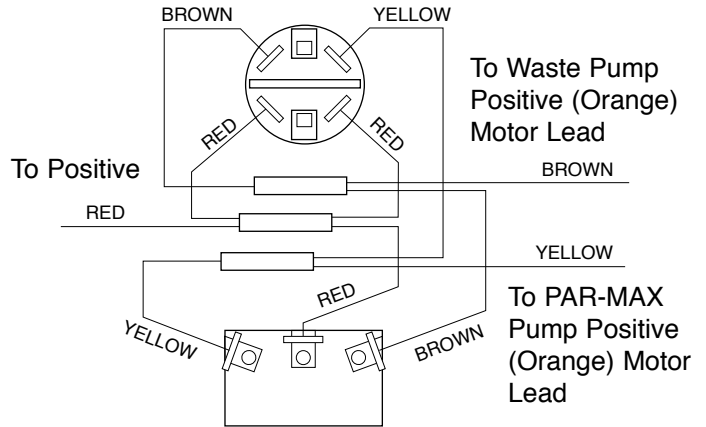

TEMPLATE

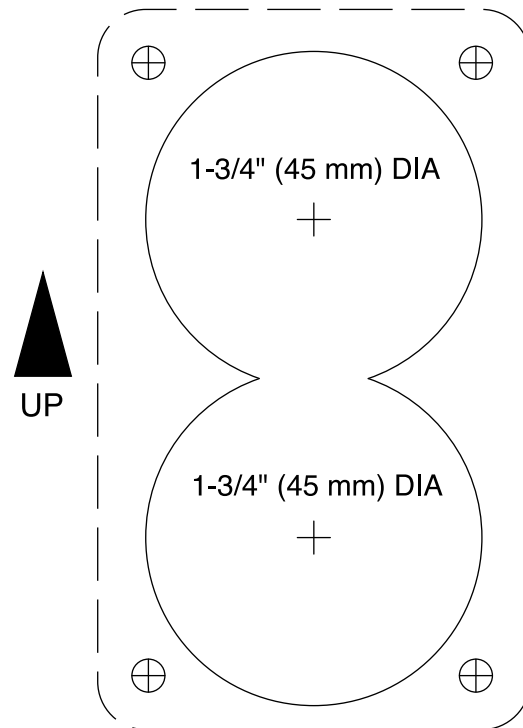

WASTE PUMP SERVICE

The Jabsco Quiet-Flush Toilet does not require maintenance other than occasional cleaning to maintain a hygienic sanitary condition. Clean toilet with mild non-abrasive cleaners without strong aromatics. Cleaners having high concentrations of aromatics such as pine scented concentrated cleaners and strongly scented degreaser concentrates can cause the pump's seal to swell and may contribute to a premature seal leak.

The toilet has no wearing parts that need periodic replacement other than the shaft seal which, under normal conditions, should provide several years of service before needing replacement. The seal only requires replacement if signs of leakage are noticed under the seal housing positioned between the motor and toilet base assembly.

	WARNING Flood hazard. If toilet is plumbed to an overboard discharge, close the discharge seacock prior to disassembling toilet. Failure to do so can result in flooding which can cause loss of property and life.
--	--

NOTICE: Before performing any service, turn off the electrical power to the toilet and rinse water pump. Take precaution to ensure it is not turned on until the service is complete. Also, pump all water from the toilet bowl and if connected to an overboard discharge, close the discharge seacock.

To replace the shaft seal, snap off the white motor cover and remove the pump assembly by removing the four screws with lock washers that secure it to the toilet base.

Carefully slide the pump assembly from the base ensuring the macerator housing also slides out of the base with the pump. The pump chopper will engage the macerator housing and it may be necessary to gently tap the chopper against the macerator housing to free it from the base.

Prevent the motor shaft from turning by inserting a screwdriver in the shaft slot at the rear of the motor and unscrew the nut. Remove the chopper blade and macerator housing from the motor shaft. Remove the O-ring from the O-ring groove around the outer diameter of the seal housing. With an allen wrench, loosen the centrifugal impeller set screw and slide the impeller off the shaft. Remove the two screws that secure the seal housing to the motor and slide the housing off the motor shaft. Remove the two seal washers from under the head of each of the two seal housing retainer screws. With a pair of needle nose pliers, grasp the shaft seal and pull it from the seal housing. Clean all parts and inspect for damage.

Lubricate the OD of the new seal with a small amount of water and press it into the seal bore with the seal's lip facing the threaded end of the shaft. Do not use the stainless steel star retaining washer supplied with the seal. Lubricate the ID of the seal and the motor shaft with a small amount of water resistant grease. Ensure the slinger is properly positioned on the motor shaft next to the motor and slide the seal housing onto the motor shaft until it is against the motor end bell. Position a new plastic seal washer under the head of each of the flat head seal housing retainer screws and secure the seal housing to the motor. Slide the centrifugal impeller on the motor shaft positioning it about 1/32" (1 mm) from the seal housing and secure it to the shaft with the set screw. Rotate the impeller to ensure it does not rub on the seal housing.

Slide the macerator housing over the motor shaft, place the chopper plate on the end of the shaft and screw the locking nut onto the shaft. Tighten the nut while holding the motor shaft at the rear of the motor. Position a new O-ring in the seal housing O-ring groove (it may be retained in the groove with a small amount of grease). Slide the pump assembly into the toilet base ensuring the macerator housing is properly positioned within the base. The cut-out in the side of the macerator housing must align with the discharge port in the base (the macerator housing is keyed so it will only go in when properly positioned). Ensuring the O-ring is still properly positioned in the O-ring groove in the seal housing, place the pump assembly against the base and secure it in place with the four screws and lock washers. Replace the white motor cover by snapping it down over the pump motor.

PAR-MAX 2.9 Rinse Pump Service

Please refer to the Data Sheet provided for the 31331-Series Rinse pump.

EXPLODED VIEW

Jabsco Pumps 37245-3094

www.PumpAgents.com - Click here for Pricing/Ordering for Pumps and Parts

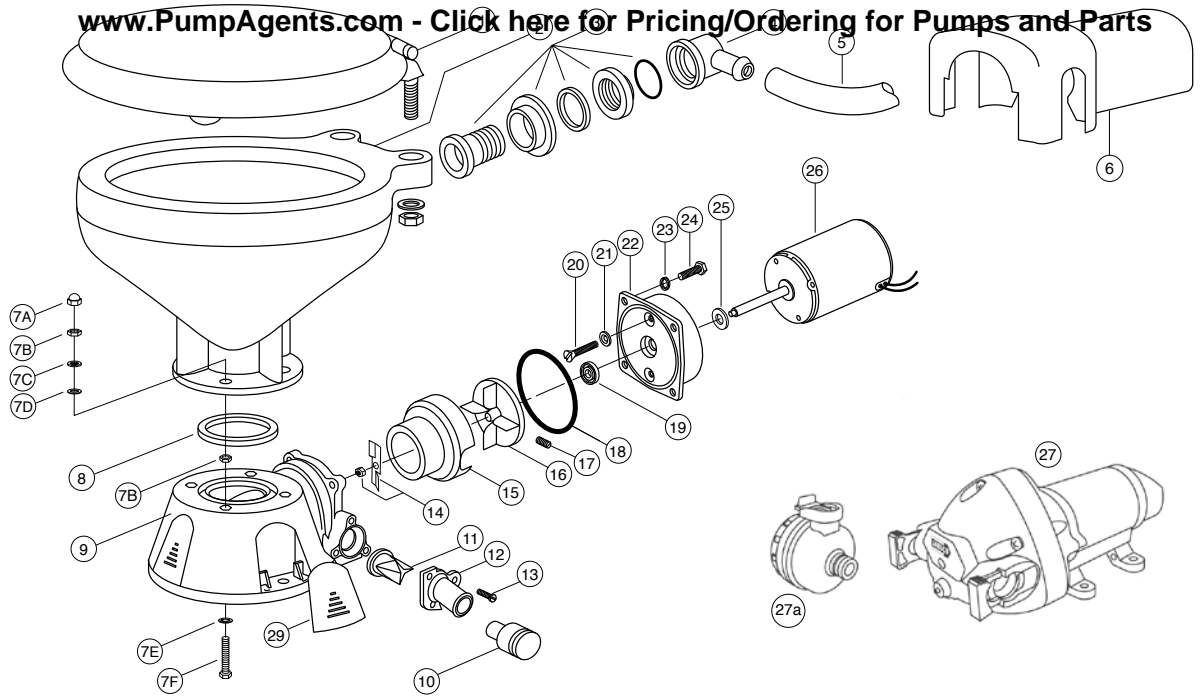

PARTS LIST

Key	Description	Qty. Req.	Part Number	Key	Description	Qty. Req.	Part Number
1.	Seat & Cover			19	Seal * †	1	1040-0000
	Note - 2018 models identified with Jabsco logo on top of bowl.			20	Screw †	2	91010-0144
	Compact	1	29097-1000	21	Washer, Plastic* †	2	35445-0000
	Regular (Pre 2018)	1	29127-1000	22	Seal Housing †	1	37043-1000
	Regular (2018 onwards)	1	58104-1000	23	Lock Washer #10, Stainless Steel†	4	
	Soft Close (2018 onwards)	1	58104-2000	24	Screw †	4	91027-0011
1a.	Hinge Sets			25	Slinger †	1	6342-0000
	Hinge Set (1 PAIR)			26	Motors:		
	Compact (ALL VARIANT)	1	29098-1000		Motor - 12 Volt EMC †	1	18753-0554
	Regular (Pre 2018)	1	29098-2000		Motor - 24 Volt EMC †	1	18753-0555
	Regular (2018 onwards)	1	58105-1000	27	PAR-MAX 2.9 Rinse Pump		
	Soft Close (2018 onwards)	1	58105-2000		12 Volt	1	31331-0092
2.	Bowl				24 Volt	1	31331-0094
	Compact	1	29096-1000	27a	Pump Guard	1	46400-9500
	Regular	1	29126-1000	28	Switch Panel	1	37047-1000
3 & 4	Bowl Spud, Intake Elbow & O-ring	1	29048-0000	29	Screw Cover (3 each)	1	37003-1000
5	Hose, 6 feet	1	29035-1031		Service Kit		90197-0000
6	Motor Cover †	1	37042-1000		Waste Pump Assembly		
7	Bowl Installation Hardware	1	18753-0637		12 Volt		37072-0092
7A	Hex Head Screw**	4			24 Volt		37072-0094
7B	Washer, Starlock**	4					
7C	Washer, Plastic**	4					
7D	Washer, Stainless Steel**	4					
7E	Hex Nut** (Two places)	8					
7F	Nut Cap**	4					
8	Bowl O-Ring Seal	1	44101-1000				
9	Base Assembly**	1	37004-1000				
10	1-1/2" Adaptor, Discharge Port	1	98023-0080				
11	Joker Valve* **	1	44106-1000				
12	1" Discharge Port**	1	44107-1000				
13	Screw**	3	96050-0568				
14	Chopper Plate with Lock Nut †	1	37056-1000				
15	Macerator Housing †	1	37014-0000				
16	Centrifugal Impeller †	1	37006-0000				
17	Set Screw †	1	18753-0492				
18	O-ring* †	1	43990-0066				

* Parts Supplied with Service Kit.
 ** Parts included with base 37004-1000.
 † Parts included in Waste Pump Assembly

Jabsco Pumps 37245-3094

Xylem limited warranty warrants this product to be free of defects and workmanship for a period of (x) years. The warranty is exclusive and in lieu of any and all other express or implied warranties, guarantees, conditions or terms of whatever nature relating to the goods provided hereunder, including without limitation any implied warranties of merchantability and fitness for a particular purpose, which are hereby expressly disclaimed and excluded.

Except as otherwise provided by law, buyer's exclusive remedy and seller's aggregate liability for breach of any of the foregoing warranties are limited to repairing or replacing the product and shall in all cases be limited to the amount paid by the buyer hereunder. In no event is seller liable for any other form of damages, whether direct, indirect, liquidated, incidental, consequential, punitive, exemplary or special damages, including but not limited to loss of profit, loss of anticipated savings or revenue, loss of income, loss of business, loss of production, loss of opportunity or loss of reputation.

This warranty is only a representation of the complete limited warranty.

For a detailed Explanation, please visit us at www.xylemflowcontrol.com/support/, call our office number listed, or write a letter to your regional office.

